



## Folded Self-Mailer Reference Material

5/30/2012

This documentation provides summarized information for the revised standards that Folded Self-Mailers (FSM) and specific Unenveloped mailpiece designs must meet to receive automation letter discounts. The revised standards that take effect January 05, 2013 can be found in the Federal Register (FR) Final published Dec 01, 2011. This reference material is divided into sections for ease-of-use. The primary section is titled "Folded Self-Mailer Decision Tree Design Matrix" with other sections to supplement it. This information is only a summarized reference tool; please refer to the FR Final DMM section 201.3.14 for official language to revised FSM standards and 201.3.15 for the specific Unenveloped mailpiece design standards.

**Definition** - A folded self-mailer is formed of panels created when a single or multiple unbound sheets of paper are folded together and sealed to form a letter-size mailpiece.

**General Standards** - this section portrays mailpiece design elements applicable to all FSM letter designs.

**Recommended Standards** - this section portrays elements that are not required, but are recommended to improve handling and/or physical integrity of the mailpiece.

**Folded Self-Mailer Decision Tree Design Matrix** - the matrix table is a summarized version of specification elements for Folded Self-Mailers (FSM). The 1<sup>st</sup> column is a list of basic and optional elements of a finished mailpiece. The 2<sup>nd</sup> column provides the standards for a **Basic FSM** format. The remaining columns identify optional features that may be incorporated into a **Basic FSM** design. The cell where rows and columns intersect portray, where applicable, standard(s) that differ from the **Basic FSM** due to utilization of an optional feature. Where a standard differs from the **Basic FSM** design, the cell background is highlighted light blue; if the standard does not change, it will state "Same as Basic FSM" and the cell background is highlighted yellow. N/A denotes the combination of elements or other feature not applicable to the finished mailpiece.

When a mailpiece contains multiple *optional design elements*, the standards in the rightmost column representing the utilized optional design apply to the mailpiece. ex: FSM has an internal attachment and Die-cutout; paper basis weight is 100lb which is the higher of the two optional elements.

**Illustrative Options of a Mailpiece** - this section provides illustration examples of variations for finished mailpieces. This list is not intended to portray every potential design for a finished mailpiece, nor is it meant to restrict mailpieces to look exactly like those shown.

### **Common Fold Methods\***

**Bi-fold**: single sheet folded once in half forming two panels.

**Tri-fold**: single sheet folded twice forming three panels.

**Quarter-fold**: single sheet folded at least two times with the second fold at a right angle (perpendicular) to the preceding fold. One sheet of paper quarter-folded produces four panels.

**Oblong**: mailpiece with fold(s) vertical to length of letter. Final fold must be on lead edge.

\* When a folded self-mailer is made of multiple sheets, multiply the number of sheets by the number of panels created when folding a single sheet to determine the number of panels in the finished multi-sheet folded self-mailer. e.g. (3) sheets of paper folded once in half (2 panels) = (6) total panels. Both sides of a panel count as "one and the same" panel.

### **Paper Basis Weights**

Standards for paper are based on Book Grade (Offset, Text) as represented in Exhibit 3.2 located in DMM section 201.3.2

## General Standards

### Dimension

Height: 3.5" min, 6" max

Length: 5" min, 10.5" max

**Weight** - 3oz max

**Flaps** – extended portion of the address side panel as the final fold over and secured to non-address side panel. Flaps are used for closure of mailpiece.

- on horizontal folded pieces, external flap must extend from top on non-address side; be a minimum 1.5"L at the longest point, but extend to no closer than 1" from bottom.

- on vertical folded pieces, external flap must extend on non-address side from lead to trail edge; be minimum 5"L at the longest point, but extend no closer than 1" from trail edge.

- die-cut shape external flaps are allowed. Edge along contour must be well sealed to panel using tabs, glue spots or elongated glueline, however a 1/8" continuous glue line to seal along the contour of the die-cut pattern's edge is highly recommended.

**Non-address side flaps**  
As shown: Lead edge is to the left, Trail edge is to the right

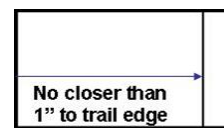
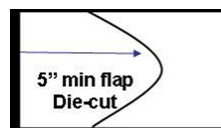
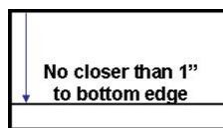
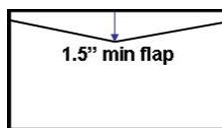

**Panels** - created when sheets of paper are folded; each folded section of a sheet is a separate panel and are equal or nearly equal in size. Both sides of a panel count as "one and the same" panel. Folded Self-Mailer letters have a minimum of two panels.

- when combinations of folding techniques are used, resulting in panels of differing sizes, shorter panels must be internal and covered by a full size panel.

- internal partial panels are counted toward the maximum number of panels permitted by design.

- the final folded panel creates the non-address side of the mailpiece by folding from bottom to top, or lead to trail edge. Panel may be shorter but not exceed 1" from the top or trail edge; however when a (2) tab configuration is applicable, lead and trail placement is required for bottom - top panel design.

### **2 Panels**

Single sheet folded once in half (bifold)



### **4 Panels**

Two nested sheets folded once in half

One sheet folded three times

One sheet quarter-folded; two folds perpendicular





### **3 Panels**

One sheet folded twice (trifold)



## General Standards

**Closure Method: Glue** - adhesive or cohesive applied as a continuous line (preferred), glue spots or elongated glue lines placed within 1/4" of edge(s)\*  
 \*illustrations of glue closure represented below are not to scale.

<p><b>Continuous Glue Line</b></p> <p>1/8" wide to within 1/4" of each edge</p>		<p><b>Glue Spots</b></p> <p>3/8" diameter</p> <p>3 - 4 spots based on mailpiece design / wgt</p>		<p><b>Elongated Glue Lines</b></p> <p>1/8" W x 1/2" L or 1/4" W x 1/2" L or 1/8" W x 1" L</p> <p>3 - 4 lines based on mailpiece design / wgt</p>	
---	---	--	---	--	---

**Closure Method: Tab** - non-perforated wafer seals or tabs are applied to top, or lead and trail edge to secure a folded self-mailer letter closed.\*  
 \*illustrations of tabs represented below are not to scale.

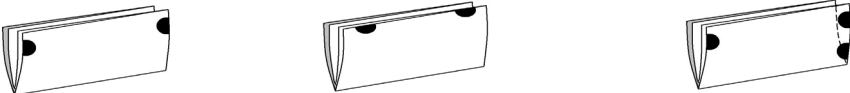
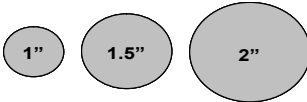
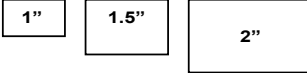
<p><b>Non-Perforated Tabs</b></p> <p>2- 3 tabs required based on mailpiece design</p> <p>Placement – either at top or on lead/trail edge within 1" of adjacent edge(s). Lower lead edge tab placed within 1/2" of bottom edge.</p>	 <p style="text-align: center; font-size: small;">Address side shown: Trail edge is to the left, Lead edge is to the right</p>	 
--	--	--

## Other Elements

**Thumb / Insertion Notch** - a 1/2" semi-circular die-cut notch may be placed only on the trail edge of the address or non-address panel.



**Internal Attachments / Loose enclosures**

- if multiple attachments are adhered, they must be nearly uniform in thickness.
- if multiple attachments are adhered on separate panels, but in stacked alignment, combined thickness is applied to maximum thickness allowed.
- where multiple attachments are placed adjacent across length, the thickest attachment applies toward the maximum thickness allowed.
- loose enclosures must be secured in a pocket or another method that ensures containment within mailpiece and prevents excessive shift.

## Recommended Standards

**Co-Efficient of Friction**

- kinetic coefficient of friction (paper to same paper) 0.26 to 0.34

**Static**

- static charge less than 2.0kv

**Paper Cover Coating**

- full coverage coating.

**Address Placement**

- when paper is uncoated, addresses should be placed in a mid to left position within the optical character reader (OCR) area as defined in DMM 202.2.1

## Folded Self-Mailer Standards - Decision Tree Design Matrix

DMM 201.3.14-15 must be referenced for official standards	Basic FSM	Optional Mailpiece Design Elements (per DMM 201.3.14*)				Tear-off Opening Device on Lead and/or Trail Edge (Unenveloped per DMM 201.3.15.2)
		Quarter-Fold	Interior Attachments or Loose Enclosures in Pocket	Perforations on Cover Non-Address Side Only	Die-Cutout Windows on Cover Address or Non-address Side	
<b>Paper Basis Weight Book Grade (min) (Text, Offset)</b>	70lb up to 1oz 80lb over 1oz	70lb up to 1oz 80lb over 1oz Newsprint - 55lb minimum and only allowed with the Quarter-fold design	80lb up to 1oz 100lb over 1oz	100lb up to 1oz 120lb over 1oz	100lb up to 1oz 120lb over 1oz	60lb min 80lb recommended if over 1oz or contains inserts
<b>Fold Style / Orientation</b>	Horizontal - final fold on bottom Full panel folded up to top on non-address side or External flap folded down from top of non-address side.  Vertical (Oblong) - final fold on Lead edge to non-address side Trail edge	Quarter-Fold - first fold at Lead edge; final fold on bottom edge	Same as Basic FSM or *Open-Sleeve (Unenveloped - 201.3.15.1) - two symmetrical horizontal panels sealed together along top & bottom using 1/8" continuous glue line. If flaps are used they must be 1.5" min inner flaps glued together.	Same as Basic FSM	Same as Basic FSM or *Open-Sleeve (Unenveloped - 201.3.15.1) - two symmetrical horizontal panels sealed together along top & bottom using 1/8" continuous glue line. If flaps are used they must be 1.5" min inner flaps glued together.	N/A
<b>Closure Method - Glue</b> (outermost spots or lines must be within 1/4" of edges)  <b>Not applicable with nested sheets</b>	Up to 1oz - 1/8" W continuous glue line or (3) 3/8" spots or (3) elongated glue lines 1/8" W x 1/2" L  Over 1oz - 1/8"W continuous glue line or (4) 3/8" spots or (4) elongated glue lines 1/8" W x 1" L or 1/4" x 1/2"	N/A Glue seal method cannot be used on this mailpiece	Up to 1oz - 1/8"W continuous glue line or (4) 3/8" spots or elongated glue lines 1/8" W x 1/2" L  Over 1oz - same as Basic FSM over 1oz standard	Up to 1oz - 1/8"W continuous glue line or (4) 3/8" spots or elongated glue lines 1/8" W x 1/2" L  Over 1oz - same as Basic FSM over 1oz standard	Up to 1oz - 1/8"W continuous glue line or (4) 3/8" spots or elongated glue lines 1/8" W x 1/2" L  Over 1oz - same as Basic FSM over 1oz standard	Complete seal along unfolded edges.  A perforated horizontal line joining the Lead and Trail edge perforation is allowed.
<b>Closure Method - Tabs</b>  (Non-Perforated)	Up to 1oz - (2) 1" tabs Over 1oz - (2) 1.5" tabs  Placement: Tabs can be placed on top within 1" of Lead/Trail edge or on Lead/Trail edge within 1" of top edge	Up to 1oz - (2) 1" tabs, Newsprint - (2) 1.5" tabs; Tabs placed either on Top within 1" of Lead/Trail edge or on Lead/Trail edge within 1" of Top;  Over 1oz - (3) 1.5" tabs placed: (2) on Lead edge - one within 1" of Top, one 1/2" from bottom and 3rd tab on Trail edge within 1" of Top	Up to 1oz - (2) 1.5" tabs placed either on Top within 1" of Lead/Trail edge or on Lead/Trail within 1" of Top edge;  Over 1oz - (2) 2" tabs placed either on Top within 1" of Lead/Trail edge or on Lead/Trail within 1" of Top edge or (3) 1.5" tabs with (2) placed on Lead edge - one within 1" of top, one 1/2" from Bottom and 3rd tab on Trail edge within 1" of Top	Up to 1oz - (2) 1.5" tabs placed either on Top within 1" of Lead/Trail edge or on Lead/Trail within 1" of Top edge;  Over 1oz - (2) 2" tabs placed either on Top within 1" of Lead/Trail edge or on Lead/Trail within 1" of Top edge or (3) 1.5" tabs with (2) placed on Lead edge - one within 1" of top, one 1/2" from Bottom and 3rd tab on Trail edge within 1" of Top	Up to 1oz - (2) 1.5" tabs placed either on Top within 1" of Lead/Trail edge or on Lead/Trail within 1" of Top edge;  Over 1oz - (2) 2" tabs placed either on Top within 1" of Lead/Trail edge or on Lead/Trail within 1" of Top edge or (3) 1.5" tabs with (2) placed on Lead edge - one within 1" of top, one 1/2" from Bottom and 3rd tab on Trail edge within 1" of Top	N/A Tabs are not used on this mailpiece
<b>Host Piece Panels</b>	2 min to 12 max	4 min to 12 panels max except Newsprint - 8 min to 24 panels max	Same as Basic FSM	Same as Basic FSM	Same as Basic FSM	N/A
<b>Interior Attachment / Loose Enclosure Thickness</b>	N/A	Internal attachment: .012 max, secured .5" from all edges  Reply envelope incorporated within first fold to prevent separation from mailpiece	.05" when total piece weight is up to 1oz .09" when total piece weight is over 1oz Attachment(s) must be secured .5" min from all edges. Loose enclosures (paper) must remain secure in pocket or other containment method (pocket does not count as a panel)	.05" when total piece weight is up to 1oz .09" when total piece weight is over 1oz Attachment(s) must be secured .5" min from all edges. Loose enclosures (paper) must remain secure in pocket or other containment method (pocket does not count as a panel)	.05" when total piece weight is up to 1oz .09" when total piece weight is over 1oz Attachment(s) must be secured .5" min from all edges. Loose enclosures (paper) must remain secure in pocket or other containment method (pocket does not count as a panel)	N/A
<b>Perforations</b>	N/A	N/A When newsprint paper is used on this mailpiece	Pull-Open Vertical Strip: 5" clear zone (non-perf) from Lead edge and 2" from Trail edge -or - Pull-Open Horizontal Strip in flap: 1" clear zone from Top edge Lead/Trail edge sealed to within 1" of Top  1mm Cut (max) to 1mm Tie (min) ratio or Dual line tear-strip - spaced 1/2" - 1" apart  *Pop-Out Pane - full perimeter perforation 4" max size 1" clear zone (non-perf) from all edges Multi-panels, must space 1" apart 1mm Cut (max) to 1mm Tie (min) ratio  *Pop-Open Pane - three sides perforated 4" max size 1" clear zone (non-perf) from all edges Multi-panels, must be spaced 1" apart 1mm Cut (max) to 1mm Tie (min) ratio  *Rectangle, Square, Circle, Oval shape	Pull-Open Vertical Strip: 5" clear zone (non-perf) from Lead edge and 2" from Trail edge -or - Pull-Open Horizontal Strip in flap: 1" clear zone from Top edge Lead/Trail edge sealed to within 1" of Top  1mm Cut (max) to 1mm Tie (min) ratio or Dual line tear-strip - spaced 1/2" - 1" apart  *Pop-Out Pane - full perimeter perforation 4" max size 1" clear zone (non-perf) from all edges Multi-panels, must space 1" apart 1mm Cut (max) to 1mm Tie (min) ratio  *Pop-Open Pane - three sides perforated 4" max size 1" clear zone (non-perf) from all edges Multi-panels, must be spaced 1" apart 1mm Cut (max) to 1mm Tie (min) ratio  *Rectangle, Square, Circle, Oval shape	N/A Die-cutout and perforation elements on exterior panel cannot be combined on this mailpiece	Tear-off strips 9/16" max width  Up to 1oz - 1mm Cut(max) to 1mm Tie(min) ratio recommended  Over 1oz - 1mm Cut(max) to 2mm Tie(min) ratio recommended
<b>Die-cutout</b>	N/A	N/A When newsprint paper is used	One Address window - up to 2"H x 4"L or (1) to (2) die-cut holes on (1) external panel - must be placed at least 1.5" apart - circular with a 2" max diameter - rectangular; 1.5" H x 2"L with .25" radius corners  Die-cut holes on non-address side must be at least 5" from Lead & 1.5" from other edges.	N/A Perforations and die-cutout elements on exterior panel cannot be combined on this mailpiece	One Address window - up to 2"H x 4"L or (1) to (2) die-cut holes on (1) external panel - must be placed at least 1.5" apart - circular with a 2" max diameter - rectangular; 1.5" H x 2"L with .25" radius corners  Die-cut holes on non-address side must be at least 5" from Lead & 1.5" from other edges.	N/A

These represent some of the variations for fold-style, closure method, and optional elements of a finished mailpiece.

Basic Folded Self-Mailer Styles

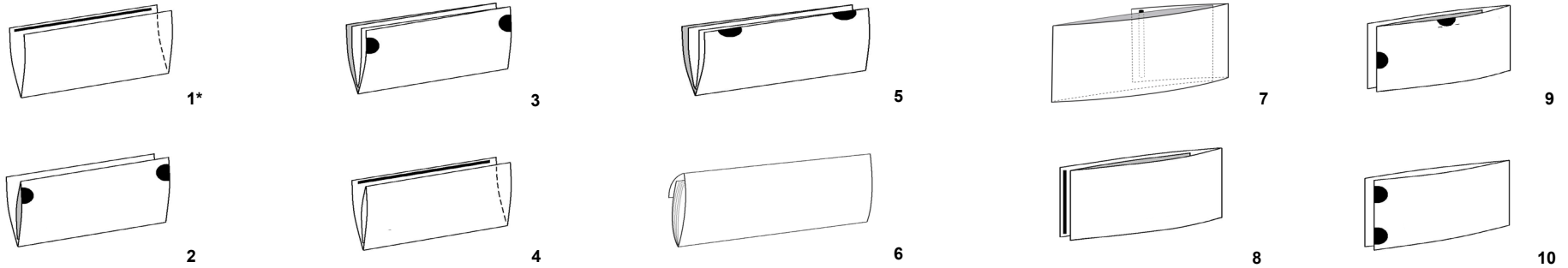

Quarter-Fold Style



Attachments or Loose Enclosures in Pocket (Internal)

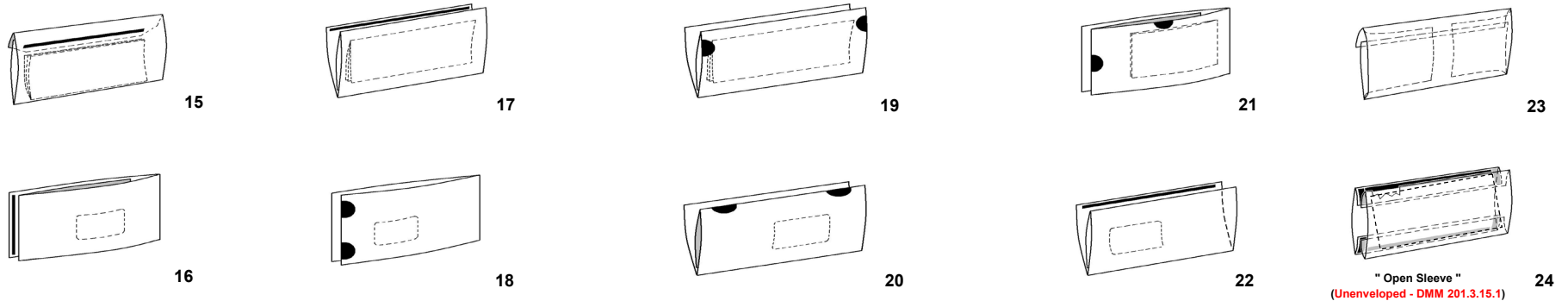

Perforated Tear-Off Devices on Lead or Trail Edge (Unenveloped - DMM 201.3.15.2)



Die-Cutout

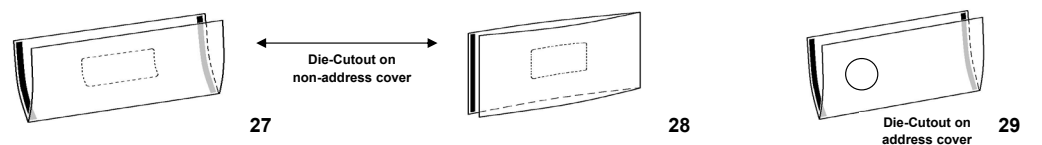

Perforations on non-Address Side Panel

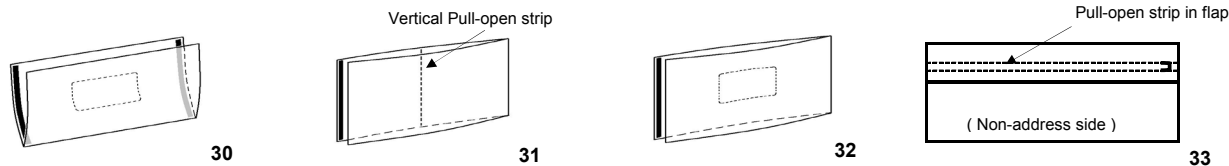

These illustrations are only intended to visually represent some of the potential variations of fold style / orientation, # panels, and closure methods. Designs are not restricted to these.\*

Horizontal folded pieces: 1-6, 11-15, 17, 19-20, 22-23, 26-27, 29-30, 33

Vertical folded pieces (Oblong): 7-10, 16, 18, 21, 25, 28, 31-32

Multi-sheet pieces: 3, 5, 25-26, \*11-14 are normally multi-sheet style

\* Glue spots or elongated glue lines may be used vs. continuous glue line; see information in General Standards - "Closure Method: Glue" section

\*Continuous or elongated glue line, or glue spots may be used on both Lead and Trail edge instead of across top edge to seal horizontal folded pieces.